



**DREDGING  
PUMPS**

**DRAGFLOW**  
ULTIMATE EFFICIENCY

**AMPHIBIOUS  
DREDGES**



**REMOTE CONTROLLED  
DREDGES**



**CABLE  
DREDGES**



**DREDGING  
PUMPS**





#### **DRAGFLOW**

A success story, which began in the 80's with the production of submersible pumps with agitator for heavy-duty applications, designed and built for the treatment of high solid abrasive mixtures.

Present recognition: today our company is known throughout the world as a manufacturer of advanced dredging pumps and systems for port, maritime, energy, mining and extraction industry sectors.

A future of research and innovation in which to develop cutting-edge technologies and solutions, with a vigilant eye on customer needs and requirements.

#### **PROJECTS and TECHNOLOGIES**

International experience attained in the design and manufacture of submersible dredging pumps has enabled us to refine our proposals: we are able to offer high quality raw materials and exceptional product life.

We constantly strive to find new opportunities for improving performance even in extreme conditions, optimising energy and thus reducing the environmental impact and total costs.

Believing that there are no difficult challenges, if they are tackled with the support of our integrated technological systems: each pump can make use of accessories able to enhance its operation in all conditions.

#### **PEOPLE**

Our team is constantly evolving to find new technological solutions, which improve the performance of electric and hydraulic dredging pumps.

Every day engineers and technicians discuss new ideas to innovate and offer specific solutions even for the most complex situations, placing particular emphasis on the needs of customers and sustainability.

Our business network is solid and widespread. Consistently supported by our partners and distributors to optimise logistics and carry out interventions quickly, with the possibility of performing inspections to demonstrate the efficiency of our products.

**Try working with us.  
You will see the difference.**

# DREDGING PUMPS. State of the art design and quality

## **ELECTRIC MOTOR DESIGNED FOR HEAVY-DUTY APPLICATIONS (1)**

Class H operates with mixtures with specific weight up to 1.7 kg/dm<sup>3</sup>. All pumps are available in 50 Hz and 60 Hz.

## **HIGH QUALITY METALLURGY (2)**

Parts subject to wear are produced using HIGH CHROME ensuring longer life.

## **SENSORS**

### **FOR EXTRA PROTECTION**

Temperature and humidity sensors are available to handle complex applications.

## **HIGH CHROME WEAR PLATE (3)**

Adjustable and positioned on the suction side.

## **FRONT DEFLECTOR (4)**

## **SERVICE BOLTS (5)**

- flushing of seals
- oil inspection
- double grease point

## **THRUST BEARINGS**

Reduce vibrations and support movement.

## **SOLID TRANSPORTING UP TO 120 MM**

Handling from 20 mm up to 120 mm in the largest pumps.



## **AGITATOR (6)**

- high efficiency agitator for lifting sedimented solid material
- able to pump up to 70% per weight density
- high abrasion resistance
- low rotation speed to reduce wear
- reversible for longer life

## **Electric version**

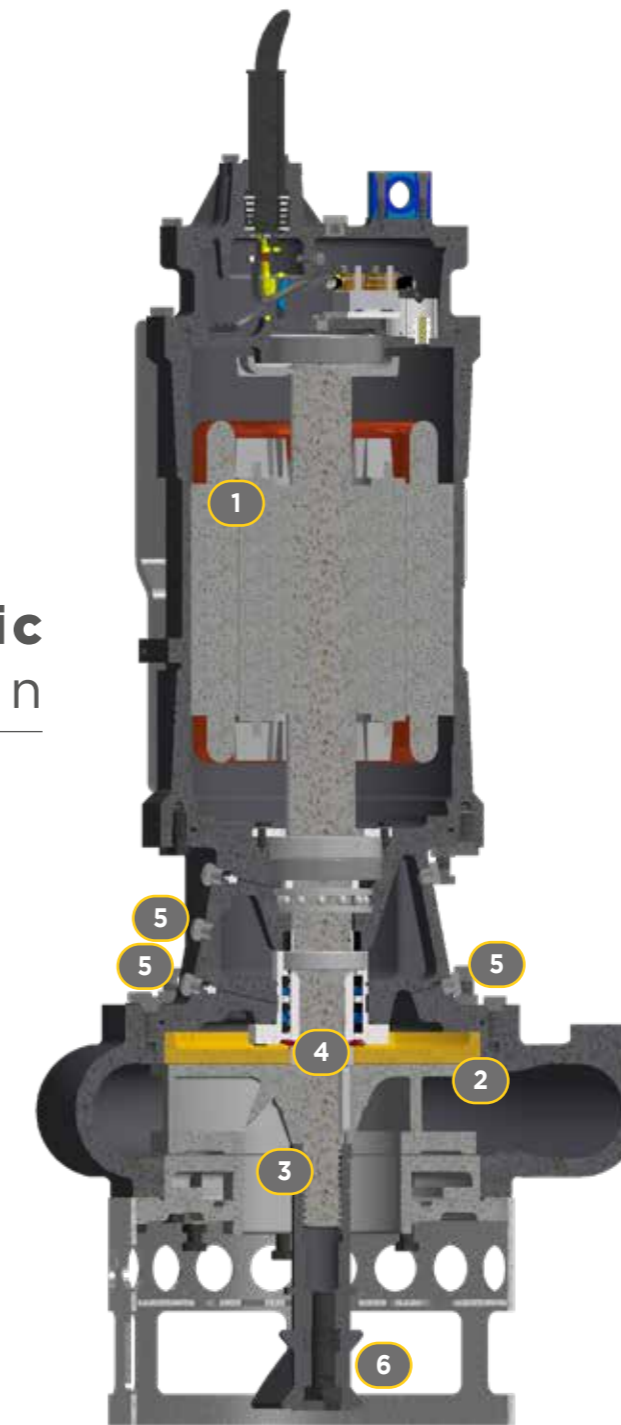

## **Hydraulic version**

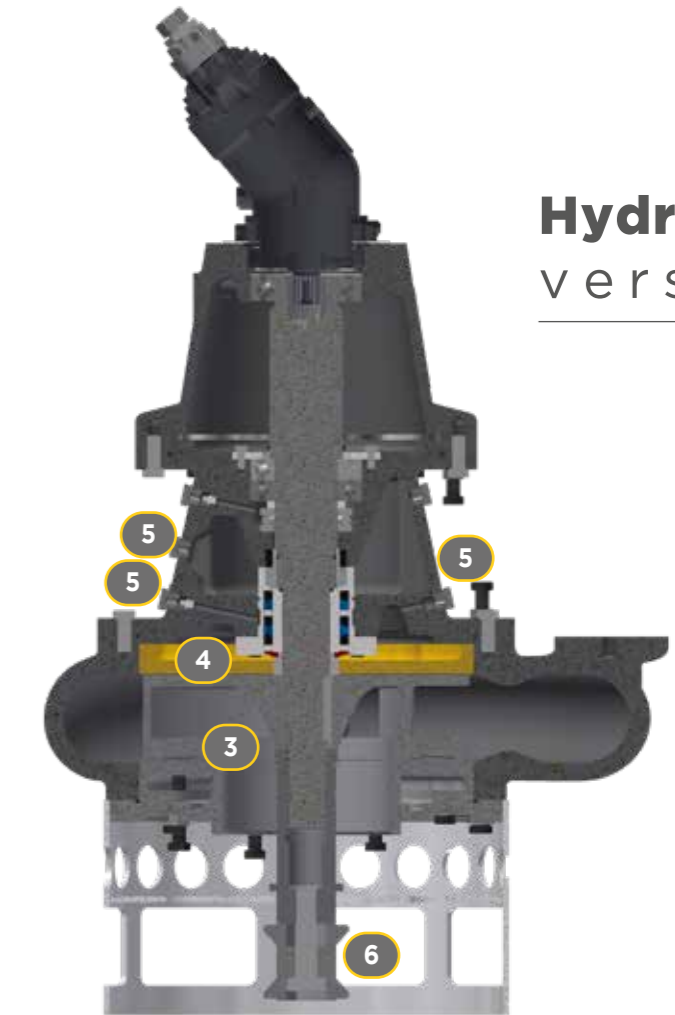



## ELECTRIC PUMPS



**Characteristics:**

- Power: from 3.7 kW (5 hp) to 240 kW (322 hp)
- Flow rate: up to 3500 m<sup>3</sup>/h
- Drain diameter: up to 450 mm (18 inches)

# PUMPS FOR HEAVY-DUTY APPLICATIONS

## S and SS versions

The pumps in this line are supplied with an oversized motor capable of lifting mixtures up to 1.7 kg/m<sup>3</sup>. Their structure is designed to work in complex environmental conditions, performing efficiently where any other pump could fail.



# ELECTRIC PUMPS EL5 - EL20



Model	Delivery		Capacity		Head		Power	R.P.M.	Solid Handling		Weight	
	mm	inch	m <sup>3</sup> /h	rpm	m	ft	HP/kW	50/60 Hz	mm	inch	kg	Lbs
EL5	80	3	30	132	12	39	5 / 3,7	1450 / 1740	20	0,8	220	485
EL7,5	100	4	60	264	12	39	7,4 / 5,5	1450 / 1740	25	1,0	270	595
EL7,5 S	100	4	60	264	12	39	10 / 7,5	1450 / 1740	25	1,0	280	617
EL7,5 SS	100	4	60	264	12	39	12 / 9	1450 / 1740	25	1,0	280	617
EL10	100	4	60	264	15	49	10 / 7,5	1450 / 1740	25	1,0	280	617
EL10 S	100	4	60	264	15	49	12 / 9	1450 / 1740	25	1,0	290	640
EL10 SS	100	4	60	264	15	49	14,7 / 11	1450 / 1740	25	1,0	290	640
EL12,5	100	4	60	264	19	62	12 / 9	1450 / 1740	25	1,0	290	640
EL12,5 S	100	4	60	264	19	62	14,7 / 11	1450 / 1740	25	1,0	290	640
EL12,5 SS	100	4	60	264	19	62	17,4 / 13	1450 / 1740	25	1,0	290	640
EL20	100	4	100	440	20	65	20 / 15	1450 / 1740	25	1,0	535	1180
EL20 S	100	4	100	440	20	65	24 / 18	1450 / 1740	25	1,0	555	1223
EL20 SS	100	4	100	440	20	65	29 / 22	1450 / 1740	25	1,0	560	1235

S = oversized motor  
SS = ultra oversized motor

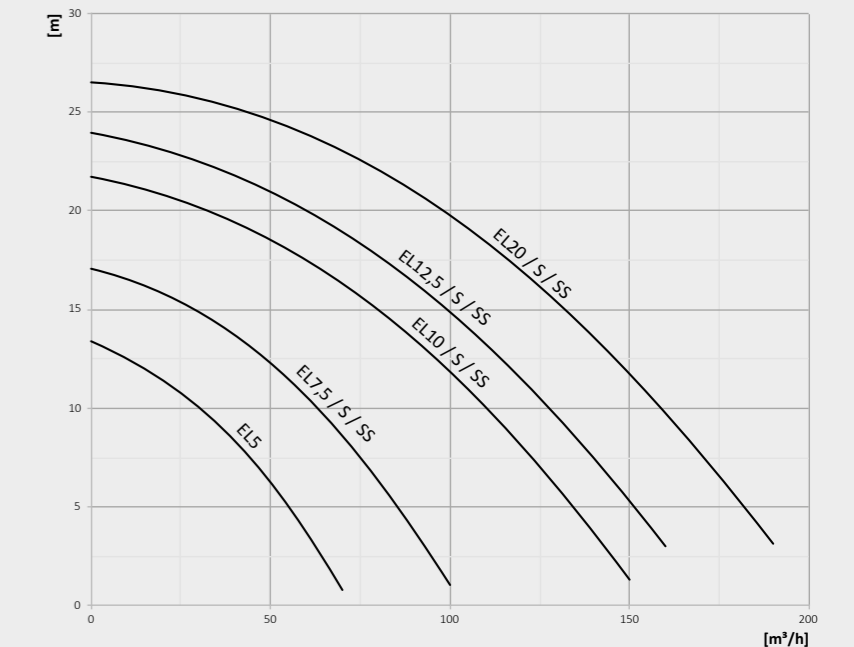

## ELECTRIC PUMPS

### EL25 - EL35

Model	Delivery		Capacity		Head		Power	R.P.M.	Solid Handling		Weight	
	mm	inch	m³/h	rpm	m	ft	HP/kW	50/60 Hz	mm	inch	kg	Lbs
EL25	100	4	100	440	21	69	25 / 18,5	970 / 1164	35	1,4	715	1580
EL25 S	100	4	100	440	21	69	35 / 26	970 / 1164	35	1,4	785	1730
EL35	100	4	90	396	31	102	35 / 26	970 / 1164	35	1,4	780	1580
EL35 S	100	4	90	396	31	102	60 / 45	970 / 1164	35	1,4	780	1580
EL35 HC	100	4	210	925	15	49	35 / 26	970 / 1164	60	2,4	780	1580

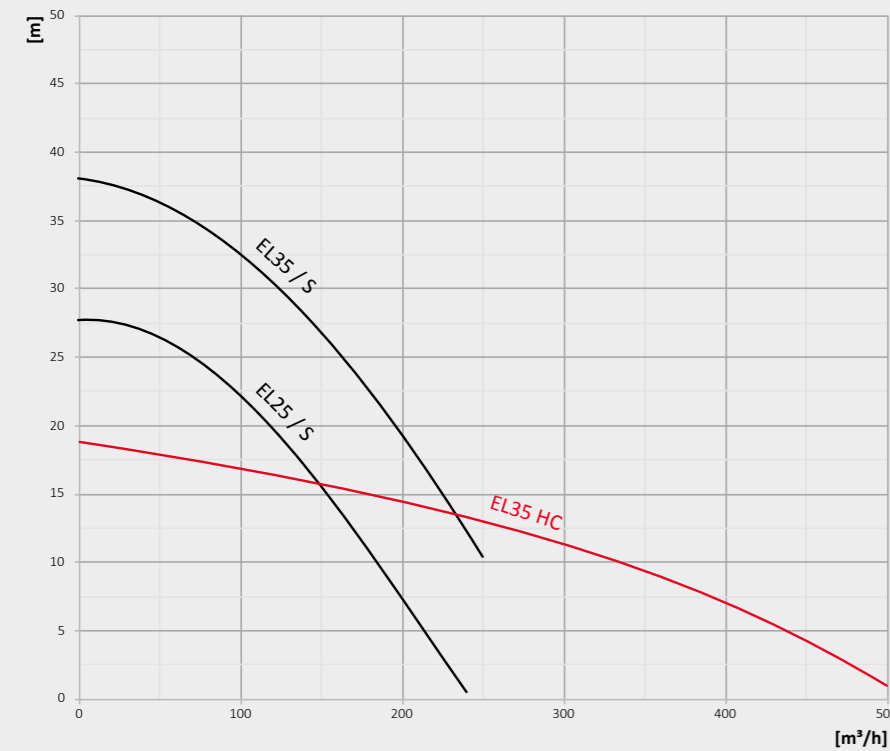

S = oversized motor  
HC = high capacity



## ELECTRIC PUMPS

### EL60 - EL1204

Model	Delivery		Capacity		Head		Power	R.P.M.	Solid Handling		Weight	
	mm	inch	m³/h	rpm	m	ft	HP/kW	50/60 Hz	mm	inch	kg	Lbs
EL60	150	6	200	881	26	85	60 / 45	980 / 1176	60	2,4	1060	2337
EL60 S	150	6	200	881	26	85	80 / 60	980 / 1176	60	2,4	1230	2710
EL60 HC	250	10	720	3170	5	16	60 / 45	980 / 1176	90	3,5	1200	2645
EL60 SHC	250	10	720	3170	5	16	80 / 60	980 / 1176	90	3,5	1200	2645
EL604	150	6	200	881	42	138	100 / 75	1480 / 1776	60	2,4	1100	2425
EL604 S	150	6	200	881	42	138	120 / 90	1480 / 1776	60	2,4	1115	2460
EL606	150	6	240	1057	38	125	100 / 75	NA / 1182	60	2,4	1250	2755
EL606 S	150	6	240	1057	38	125	120 / 90	NA / 1182	60	2,4	1280	2820
EL1204	150	6	200	881	47	154	120 / 90	1480 / 1776	60	2,4	1250	2755
EL1204 HC	250	10	720	3170	16	52	120 / 90	1480 / NA	90	3,5	1250	2755



S = oversized motor  
HC = high capacity

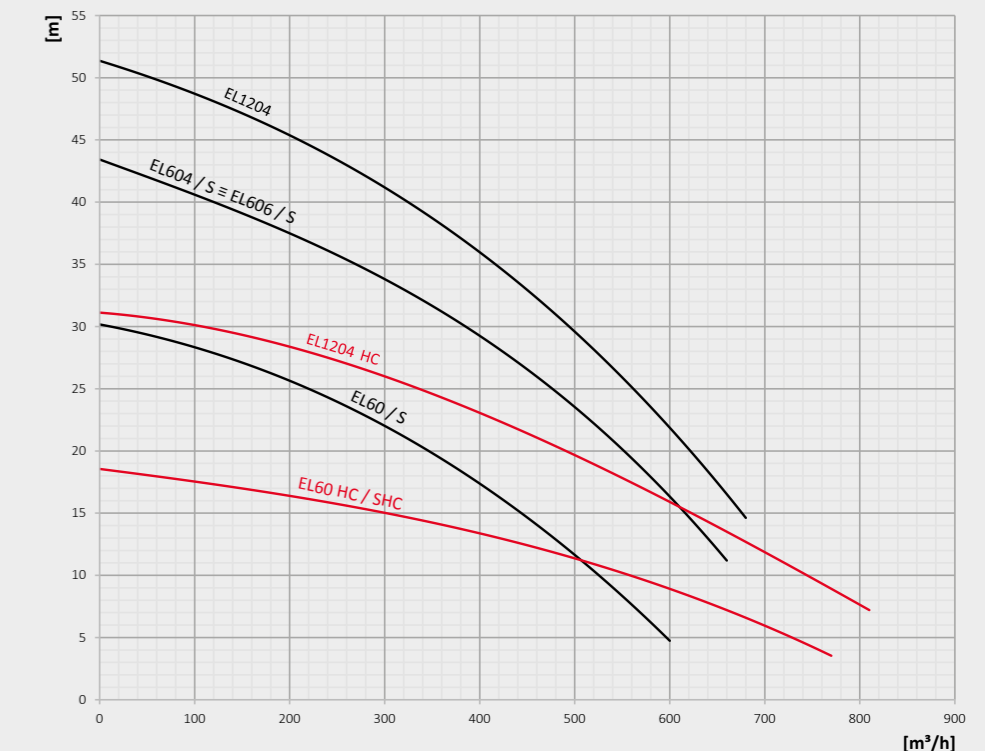

# ELECTRIC PUMPS

## EL110 – EL200



Model	Delivery		Capacity		Head		Power	R.P.M.	Solid Handling		Weight	
	mm	inch	m³/h	rpm	m	ft	HP/kW	50/60 Hz	mm	inch	kg	Lbs
EL110	200	8	350	1541	30	98	107 / 80	745 / 894	60	2,4	2450	5400
EL110 S	200	8	350	1541	30	98	150 / 110	745 / 894	60	2,4	2450	5400
EL180	200	8	350	1541	40	131	180 / 130	980 / 1176	60	2,4	2750	6060
EL180 S	200	8	350	1541	40	131	201 / 150	980 / 1176	60	2,4	2900	6400
EL200	200	8	350	1541	48	157	201 / 150	980 / 1176	60	2,4	3000	6600

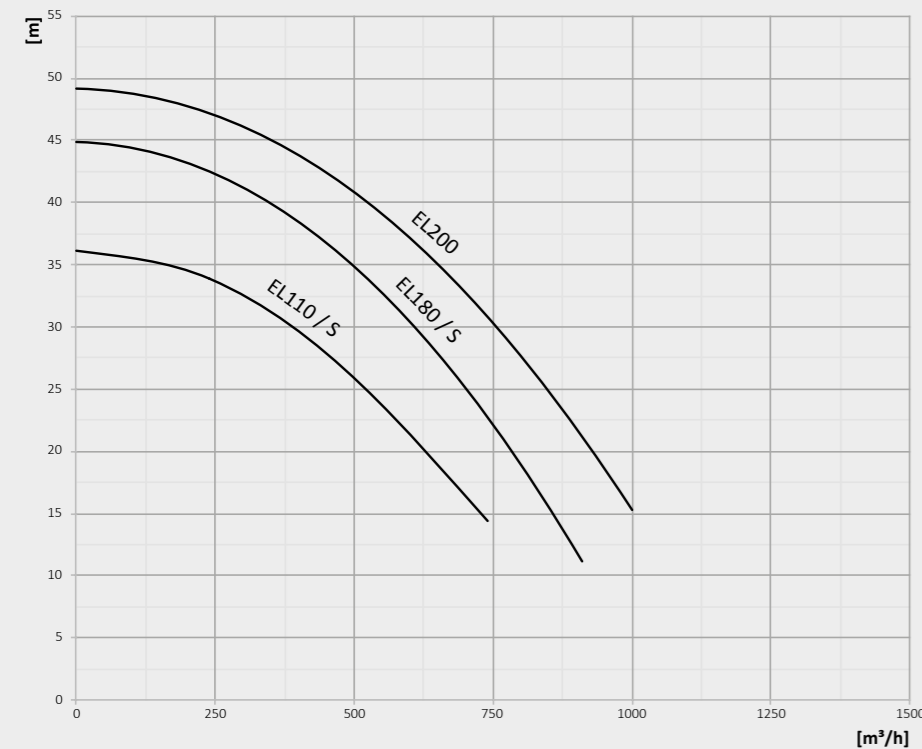

S = oversized motor



# ELECTRIC PUMPS

## EL150HC – EL300HC

Model	Delivery		Capacity		Head		Power	R.P.M.	Solid Handling		Weight	
	mm	inch	m³/h	rpm	m	ft	HP/kW	50/60 Hz	mm	inch	kg	Lbs
EL150	250	10	720	3170	22	72	147 / 110	585 / 700	120	4,7	4500	9920
EL150 HC	450	18	720	3170	22	72	147 / 110	585 / 700	120	4,7	5000	11000
EL1506	200	8	420	1850	28	90	147 / 110	980 / NA	60	2,4	2750	6060
EL300	250	10	1240	5460	35	115	322 / 240	745 / 895	120	4,7	5170	11400
EL300 HC	450	18	1700	7480	25	82	322 / 240	745 / 895	120	4,7	5420	12000



HC = high capacity

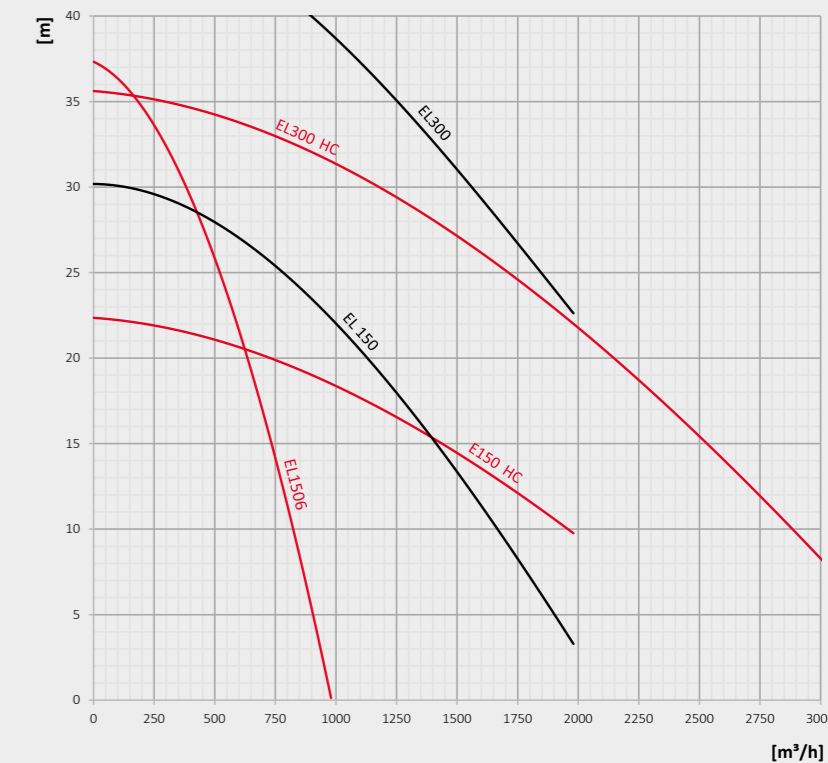



## ELECTRIC PUMPS

### EL354 - EL1204 HH



Model	Delivery		Capacity		Head		Power	R.P.M.	Solid Handling		Weight	
	mm	inch	m³/h	rpm	m	ft	HP/kW	50/60 Hz	mm	inch	kg	Lbs
EL354	100	4	60	264	46	151	49 / 37	1465 / 1758	35	1,4	780	1580
EL354 S	100	4	60	264	46	151	59 / 44	1485 / 1782	35	1,4	780	1580
EL604 HH	100	4	100	440	49	161	100 / 75	1480 / 1776	35	1,4	1250	2755
EL604 SHH	100	4	100	440	50	164	120 / 90	1480 / 1776	35	1,4	1250	2755
EL1204 HH	100	4	100	440	72	236	120 / 90	1480 / 1776	35	1,4	1250	2755
EL1204 UHH	100	4	100	440	72	236	160 / 120	1450 / 1740	20	0,8	1850	4080
EL1204 SUHH	100	4	100	440	72	236	188 / 140	1450 / 1740	20	0,8	1915	4250

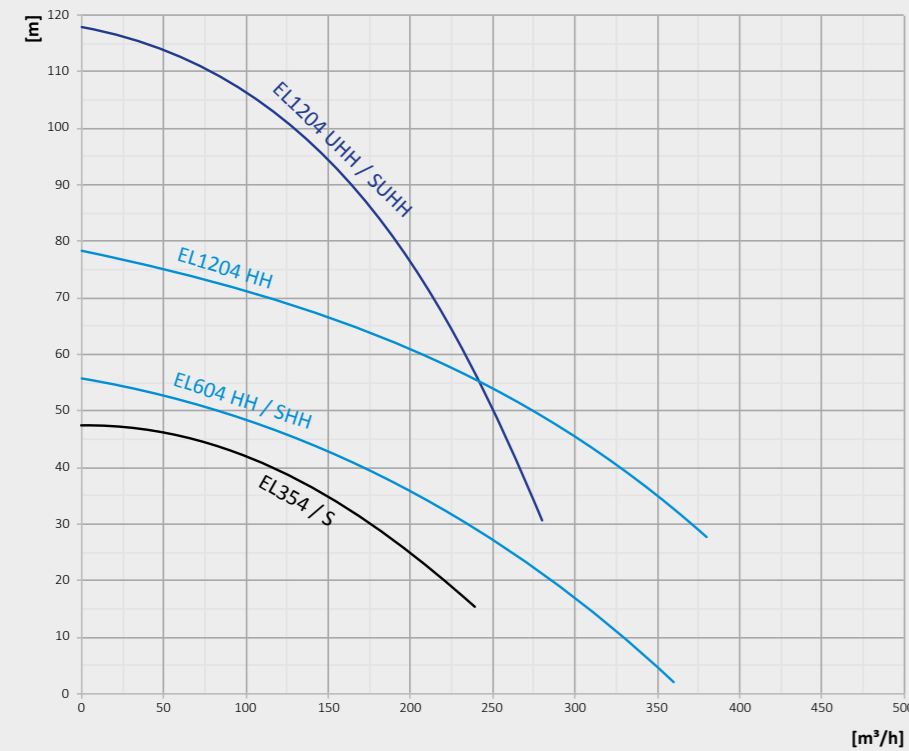

## HIGH HEAD PUMPS FOR HEAVY-DUTY APPLICATIONS

### HH Versions

Designed to transport any type of mixture, the high head line does an excellent job on heavy water and abrasive solids mixtures at a much higher pressure than any other submersible agitator pump on the market.

# HYDRAULIC PUMPS



**Characteristics:**

- Power: from 13 kW (17 hp) to 475 kW (630 HP)
- Flow rate: up to 4500 m<sup>3</sup>/h
- Drain diameter: up to 450 mm (18 inches)

# HYDRAULIC PUMPS

## HY18 - HY24



Model	Delivery		Capacity		Head		Power	R.P.M.	Solid Handling		Weight	
	mm	inch	m³/h	rpm	m	ft	HP/kW	50/60 Hz	mm	inch	kg	Lbs
HY18	80	3	50	220	17,5	57	17 / 13	2000	20	0,8	170	375
HY24	100	4	80	352	37	121	32,5 / 24	2000	25	1,0	220	485

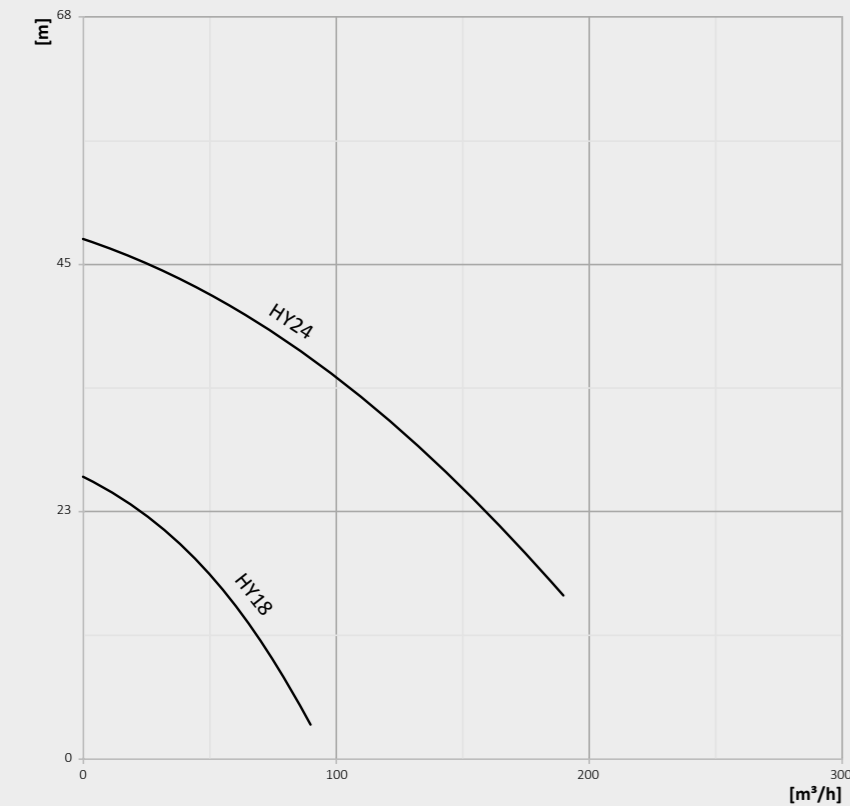

# HYDRAULIC PUMPS

## HY35 - HY85

Model	Delivery		Capacity		Head		Power	R.P.M.	Solid Handling		Weight	
	mm	inch	m³/h	rpm	m	ft	HP/kW	50/60 Hz	mm	inch	kg	Lbs
HY35	100	4	120	528	30	98	40 / 33	1180	35	1,4	530	1170
HY50	100	4	110	484	44	144	67 / 50	1180	35	1,4	610	1340
HY50 HC	150	6	250	1101	22	72	67 / 50	1180	60	2,4	700	1540
HY50/108	100	4	100	440	70	230	110 / 80	1450	35	1,4	610	1340
HY85	150	6	240	1057	37	121	87 / 65	1180	60	2,4	750	1650
HY85 HC	250	10	620	2730	16	52	87 / 65	1180	90	3,5	1030	2270
HY85/160	200	8	250	1101	56	184	165 / 120	1450	60	2,4	820	1810
HY85/160 HC	250	10	650	2862	27,5	90	165 / 120	1450	90	3,5	1100	2450
HY85/180	200	8	250	1101	56	184	170 / 130	1450	60	2,4	820	1810
HY85/180 HC	250	10	650	2862	27,5	90	170 / 130	1450	90	3,5	1150	2540



HC = high capacity

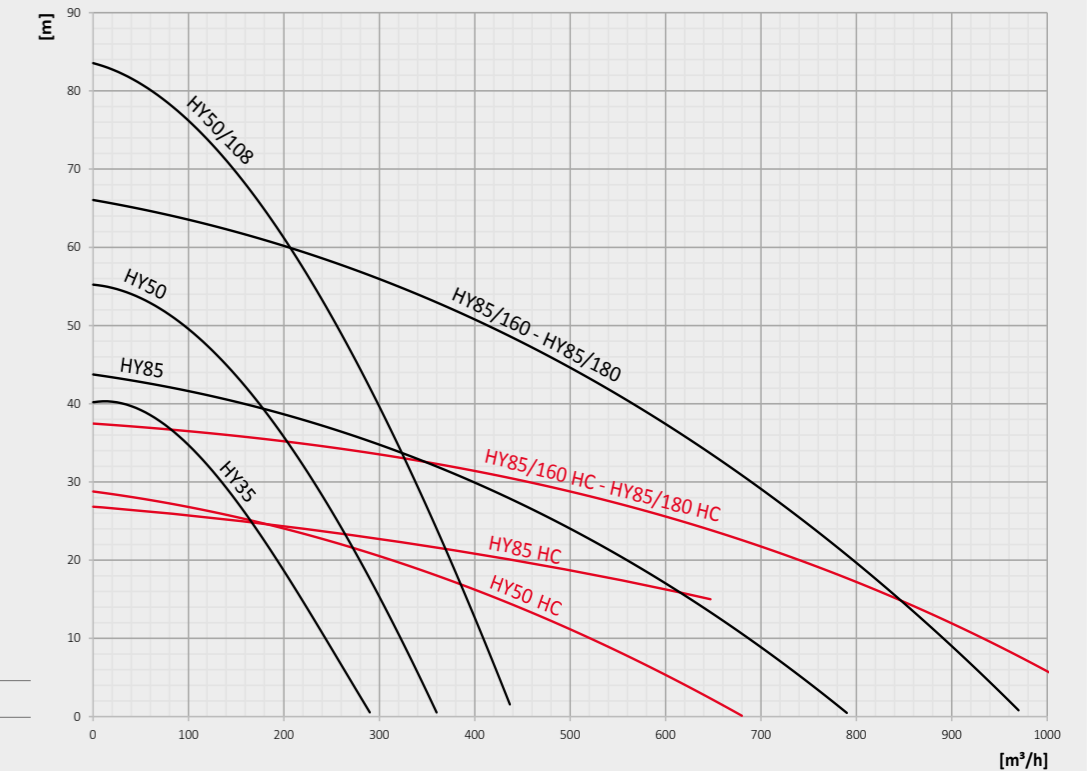

# HYDRAULIC PUMPS

## HY300 - HY600



Model	Delivery		Capacity		Head		Power	R.P.M.	Solid Handling		Weight	
	mm	inch	m³/h	rpm	m	ft	HP/kW	50/60 Hz	mm	inch	kg	Lbs
HY300	250	10	900	3963	34	112	300 / 220	750	120	4,7	3500	7700
HY300 HC	450	18	900	3963	34	112	300 / 220	750	120	4,7	4400	9700
HY400	300	12	1020	4491	44	144	400 / 300	850	120	4,7	3680	8100
HY400 HC	450	18	1020	4491	44	144	400 / 300	850	120	4,7	4500	9920
HY600	300	12	1570	6912	57	187	630 / 475	950	120	4,7	3800	8400
HY600 HC	450	18	2300	10126	32	104	630 / 475	950	120	4,7	4600	10140

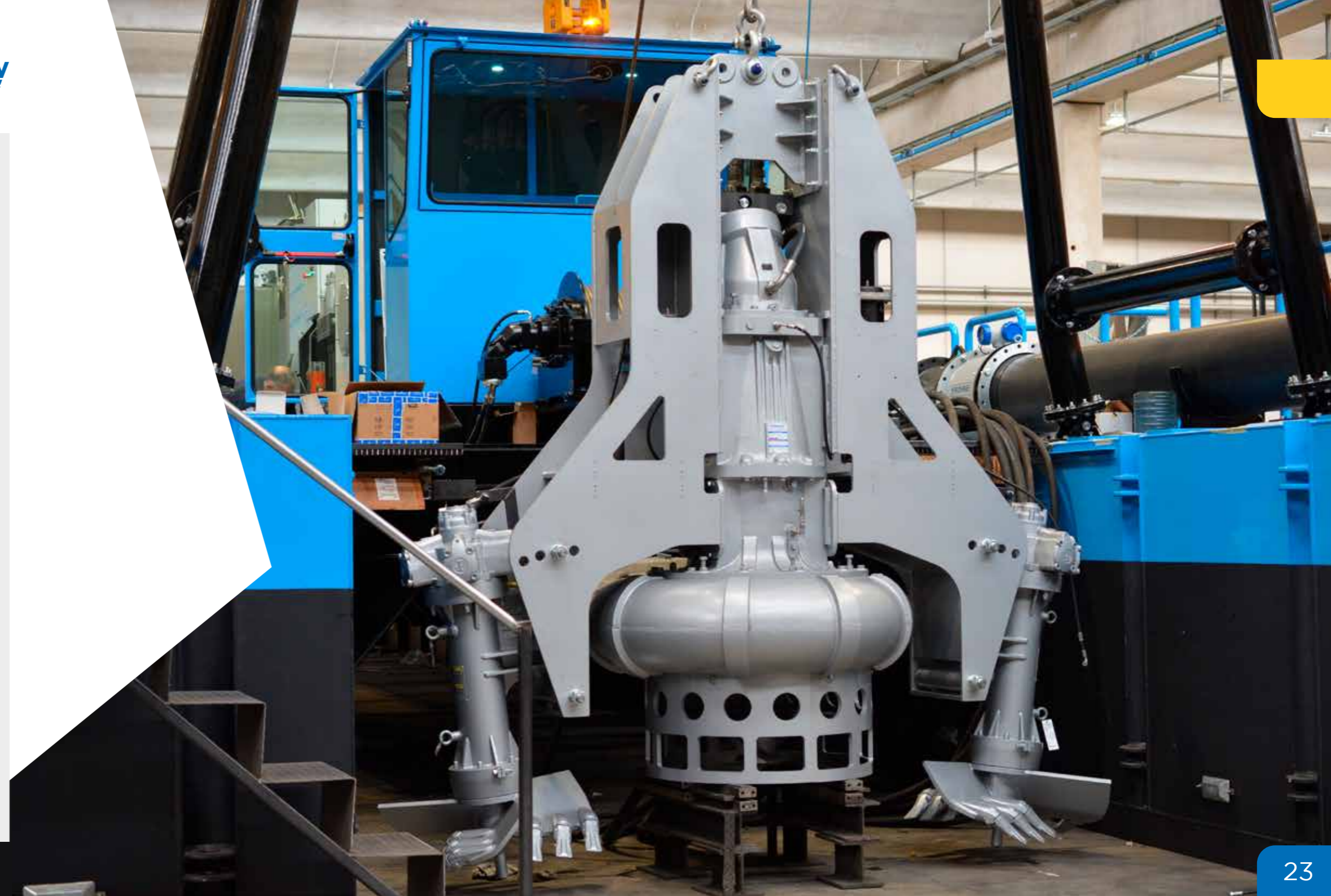
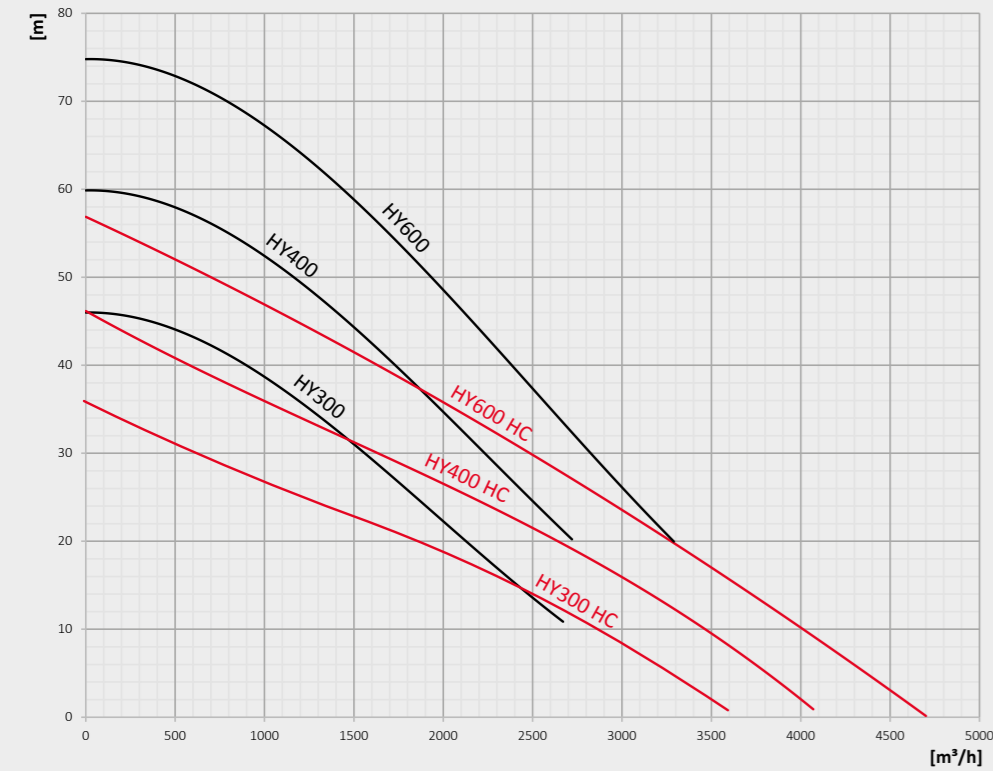

# HYDRAULIC AND ELECTRIC EXCAVATORS

## EXCAVATORS

Dragflow hydraulic and electric submersible excavators can be installed on the pump to create an autonomous excavation system for compacted soil, where an earth-moving machine would be required. They ensure a considerable increase in the average solid production of the dredging system.

### Technical specifications:

- cutting head designed to reduce the cost of wear parts due the interchangeable hard teeth present
- high efficiency and durable hydraulic or electric motor
- excavators suitable to operate up to 250 m deep by means of steel cable suspension

### Hydraulic Excavators

Model	Power (kW/HP)	Speed (RPM)	Flow rate (l/min)	Pressure (bar)
EXHY20	14,5 / 19,8	50	35	250
EXHY20S	25 / 34	50	60	250
EXHY35	25 / 34	50	60	250

### Electric Excavators

Model	Power (kW/HP)	Speed (RPM)	Voltage / Frequency (V/Hz)	Amperage
EXEL20	9 / 12,5	25	400-50 / 460-60	18,8-16,2



Hydraulic Side Cutter



Electric Side Cutter



# CUTTER HEAD

The DRAGFLOW cutting head is a custom designed system. The DRAGFLOW cutting head can be used with any DRAGFLOW hydraulic pump and can increase efficiency especially of hard and compact material.

With an independent hydraulic motor, it can be supplied with different teeth to excavate hard or soft and compact material. The arm connection frames of the earth-moving machines are supplied by DRAGFLOW and allow the operator to use it as a standard accessory.

The combined cutter head with agitator prevents any clogging at pump suction.

Model	Power (kW/HP)	Speed (RPM)	Flow rate (l/min)	Pressure (bar)
DTM50	16,7 / 22,6	30	40	250
DTM50 HC	16,7 / 22,6	30	40	250
DTM85	16,7 / 22,6	30	40	250
DTM85 HC	16,7 / 22,6	30	40	250
DTM400	52 / 70,4	50	125	250

## JET-RING

Ring with high-pressure water jets, which can be used for work on compact, extremely dry or clayey materials. Combined with electric or hydraulic pumps, works in combination or as an alternative to excavators.

### It is equipped with:

- ring frame mounted on the pump filter
- high-pressure centrifugal pump (available in electric or hydraulic version)
- suction pipe with filter and non-return valve
- delivery line



Water jet

## ACCESSORIES



### CUTTER KNIFE

When the sludge is covered by a layer of vegetation, the Dragflow algae cutting knife, together with a modified filter, will help the pump to carry out the job without clogging.

### AUTOMATIC GREASING SYSTEM

Pumps installed in a semi-fixed position, or in a "non-easily accessible" installation, can be equipped with an automatic greasing system, regularly supplying fresh grease to the seals. This operation not only increases the overall duration of the sealing system, but it also allows operators to drastically reduce pump maintenance and checks.



### ANTI-ACID

The Dragflow pump can be made completely from SUPER DUPLEX stainless steel (CD3MN) in the event of high or low PH. This choice makes the Dragflow pumps suitable for environments with a pH from 2 to 10.

### HIGH DEPTH SYSTEM

Dragflow hydraulic compensators are directly connected to the oil chamber. As the pump descends, the external pressure increases and the compensators supply oil to the oil chamber balancing the internal pressure to the external water pressure. The pump can reach over 300 m with this system, without losing performance while protecting the pump from water ingress into the oil chamber.

# HYDRAULIC POWER PACKS

## VARIABLE FLOW RATE HYDRAULIC POWER PACKS

The hydraulic power packs are specifically designed for use of the Dragflow pumps. The power packs are based on diesel engines, compliant with the latest emission requirements, or electric motors built with cutting-edge components. The hydraulic system is closed circuit, consequently the maximum flow rate can be controlled without changing the speed of the diesel engine/electric motor.

**Each Power Pack can be adapted to the needs of the customer with:**

- additional oil pumps to control auxiliary equipment (for example winches or centrifugal pumps)
- wireless remote control or advanced control panel for Power Pack monitoring from remote locations
- operator cabin and soundproofing for greater comfort during work
- container style construction

Dragflow builds and tests all Power Packs, which are supplied with the training and supervision of an experienced technician.



**Main characteristics**

IVECO or CATERPILLAR engines (other brands on request).  
Hydraulic circuit based on piston oil pumps.  
EC certification (UL and CSA available on request).  
The risk of oil leaks is avoided thanks to the completely closed bottom plate.  
Separate oil circuit for the pump and excavators.  
4 lifting points from above.

**Options**





Soundproofing.  
Operator cabin (Plug & Play system for floating platforms).  
Built in container style.  
Wireless remote control.  
Remote monitoring of work parameters.  
Possibility of operating cranes, hoists and auxiliary equipment.



**Dragflow S.r.l.**

**Head Office**

Via Paesa  
46048 Roverbella (MN) - Italy  
tel. +39 0376 1685400  
fax +39 0376 1685499  
info@dragflow.it  
www.dragflow.it

-  Dragflow
-  dragflowdredge
-  Dragflow
-  dragflowdredge
-  DRAGFLOW S.r.l.





**Dragflow S.r.l.**  
Head Office  
Via Paesa  
46048 Roverbella  
(MN) - Italy  
tel. +39 0376 1685400  
fax +39 0376 1685499  
info@dragflow.it  
www.dragflow.it